

BERT FRANK

RIDDLE 3 CLUSTER PENDANT

MAINTENANCE

- Lacquered brass or metal should be wiped with a soft duster.
- Do not clean with any liquid, chemical or abrasive cleaners.
- All electrical work must be conducted by a qualified electrician.

TECHNICAL

- 3 x G9 LED Bulb

www.berfrank.co.uk
+44 (0)207 164 6482

INSTRUCTION

- 1
- Feed electrical cable from ceiling through hole in mounting plate.
 - Fix mounting plate to ceiling using suitable fixings.

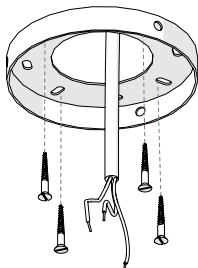

- 2
- Feed 3x Riddle Pendant flex through the spreader plate ensuring grub screw does not damage textile flex.
 - Consider the drop from the ceiling rose to the spreader plate and the spreader plate to the pendant.
 - Use grub screws in spreader plate to secure flex.

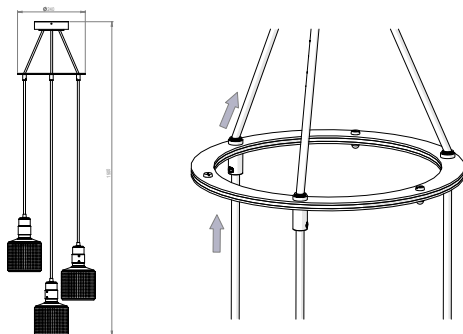

- 3
- Make electrical connection to mains power, secure flex position using grub screws and fix ceiling rose to liner using 3x screws.
 - Electrical work must be conducted by a qualified electrician.

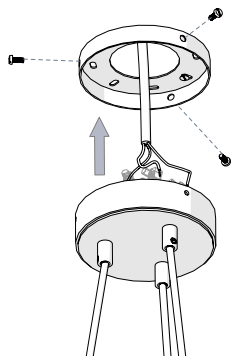

- 4
- Insert G9 LED bulb.
 - To replace, turn bulb off and let cool for 10 minutes.
 - Remove and replace with G9 LED bulb only.

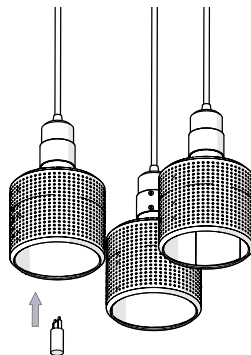

This product is only suitable for connection to the native power supply to which the unit was specifically manufactured. It is for indoor use only, and not suitable for a bathroom location.

If the Class II, double insulated symbol is on the lamp, it does not require an Earth, and Live or Neutral must not be connected to Earth. If there is no such symbol, then the lamp must be Earthed.

Under no circumstances must this lamp be covered with any material as this could pose a safety hazard. It must be used on a stable, flat surface.

Never fit bulbs of a higher wattage than those specified on the label, as these may cause overheating and damage the fitting. If the mains cable becomes damaged it must only be replaced by a technically competent, qualified person.

Allow 10 minutes to cool before replacing, adjusting or cleaning. Clean with a dry cloth only. Do not use liquid or abrasive cleaners on this product.

If you are in any doubt about your competence please consult a qualified electrician. If any modification is made it will invalidate the warranty and may render the product unsafe.

BERT FRANK

RIDDLE 5 CLUSTER PENDANT

MAINTENANCE

- Lacquered brass or metal should be wiped with a soft duster.
- Do not clean with any liquid, chemical or abrasive cleaners.
- All electrical work must be conducted by a qualified electrician.

TECHNICAL

- 5 x G9 LED Bulb

www.berfrank.co.uk
+44 (0)207 164 6482

INSTRUCTION

- 1
- Feed electrical cable from ceiling through hole in mounting plate.
 - Fix mounting plate to ceiling using suitable fixings.

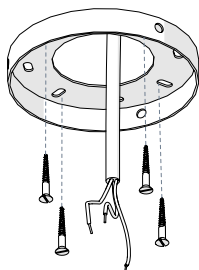

- 2
- Feed 4x Riddle Pendant flex through the spreader plate ensuring grub screw does not damage textile flex.
 - Consider the drop from the ceiling rose to the spreader plate and the spreader plate to the pendant.
 - Use grub screws in spreader plate to secure flex.

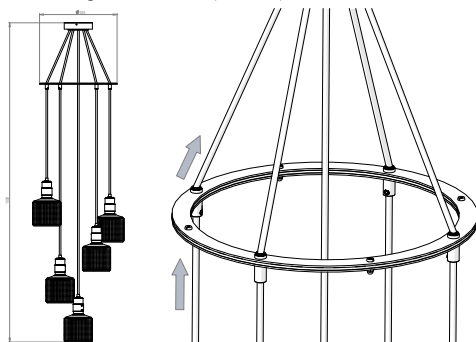

- 3
- Make electrical connection to mains power, secure flex position using grub screws and fix ceiling rose to liner using 3x screws.
 - Electrical work must be conducted by a qualified electrician.

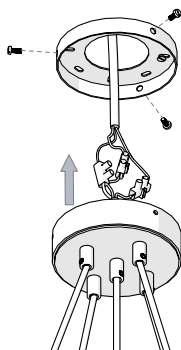

- 4
- Insert G9 LED bulb.
 - To replace, turn bulb off and let cool for 10 minutes.
 - Remove and replace with G9 LED bulb only.

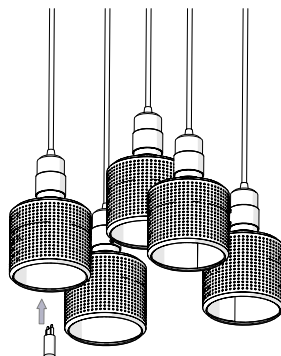

This product is only suitable for connection to the native power supply to which the unit was specifically manufactured. It is for indoor use only, and not suitable for a bathroom location.

If the Class II, double insulated symbol is on the lamp, it does not require an Earth, and Live or Neutral must not be connected to Earth. If there is no such symbol, then the lamp must be Earthed.

Under no circumstances must this lamp be covered with any material as this could pose a safety hazard. It must be used on a stable, flat surface.

Never fit bulbs of a higher wattage than those specified on the label, as these may cause overheating and damage the fitting. If the mains cable becomes damaged it must only be replaced by a technically competent, qualified person.

Allow 10 minutes to cool before replacing, adjusting or cleaning. Clean with a dry cloth only. Do not use liquid or abrasive cleaners on this product.

If you are in any doubt about your competence please consult a qualified electrician. If any modification is made it will invalidate the warranty and may render the product unsafe.
